

Varenummer: 0118022
 Beskrivelse: Seeger låsering H 9

Mål

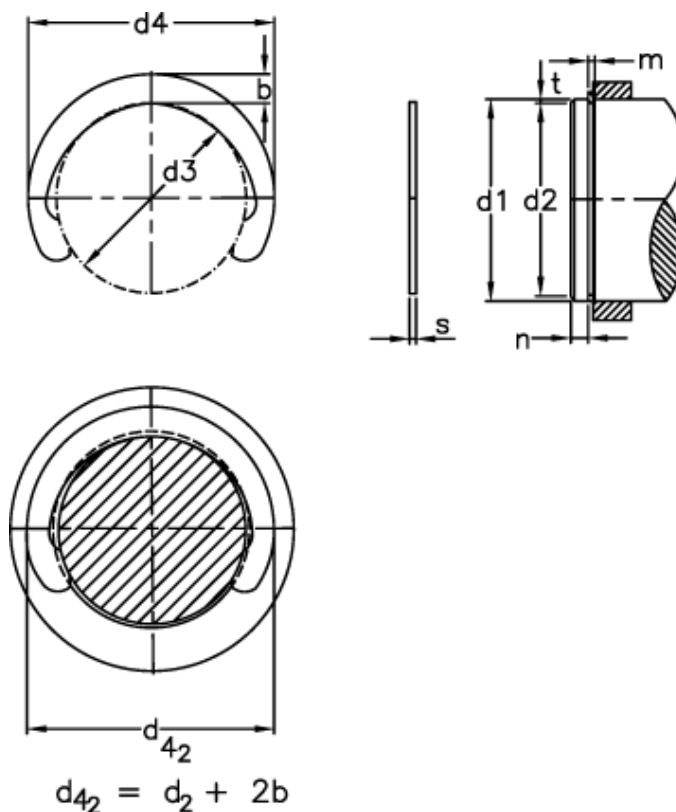

b	= 1.70	FRg kN	= 2.0	t	= 0.50
Betegnelse	= H 9,0	FR kN	= 3.50	tol	= -0.09
d1	= 9	g	= 1.00	tol	= 0.09
d2	= 8.0	Griber	= GRH 9	tol	= -0.06
d3	= 7.80	m min	= 1.10	vægt kg/1000	= 0.22
d4	= 11.20	n abl x 1000	= 58		
d4 2	= 11.4	Nominel træk	= 1.5		
FN kN	= 1.10	s	= 1.00		